

# TURTLE GT SYSTEMS

is a fully modular outdoor events structure. This system has no limitation on how big it can become, only the size of the installation site will dictate this! Multiple central hubs can be zipped together creating an ever expanding space.

# Evolution Dome



- External Dimension:** > 15m x 10.2m x 5.5H (when inflated)  
> 15m x 14m (with silenced fan units)
- Door Heights:** > 2m
- Max Internal Dimensions:** > 14m x 8.3m max – height 4.7m
- Max Usable Floor Area:** > 116m<sup>2</sup>
- Due to Shape of Structure these dimensions are approximate**
- Min Build Site Area:** > 19m x 15m
- Capacity:**
- Seating:** > See Capacity Diagrams
- Exhibition:**
- Standing:**
- Min Set Up Crew Required:** > 2 People
- Min Set Up Time:** > 12 hours
- Min Inflation Time:** > 15 mins
- Min Secure Power Required:** > 12KVA
- Fans:** > 1 x 1.5HP
- Ground Fixings:** > 20 x Terra Bolts or 9 tonnes of Ballast
- Dimension Structure:** > 1200mm x 1200mm x 1200mm  
(De-flated & Packed)
- Weight Structure:** > Gross 330 Kgs  
(De-flated & Packed) Nett 280 Kgs

EXTERNAL DIMENSIONS & ARRANGEMENT

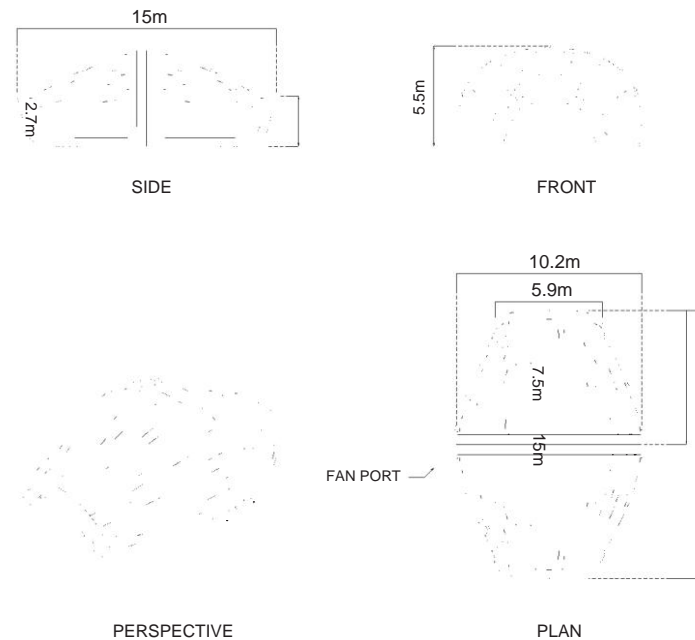

- Dimension Fan:** > 560mm x 275mm x 530mm per fan
- Weight Fan:** > 16Kgs per fan
- Colour:** > White / Frosted / Silver or Black out / Silver
- Core Package:** > Structure x 2 halves, bag x 2, storm flap, night sheet x 2, ground sheet, instruction manual

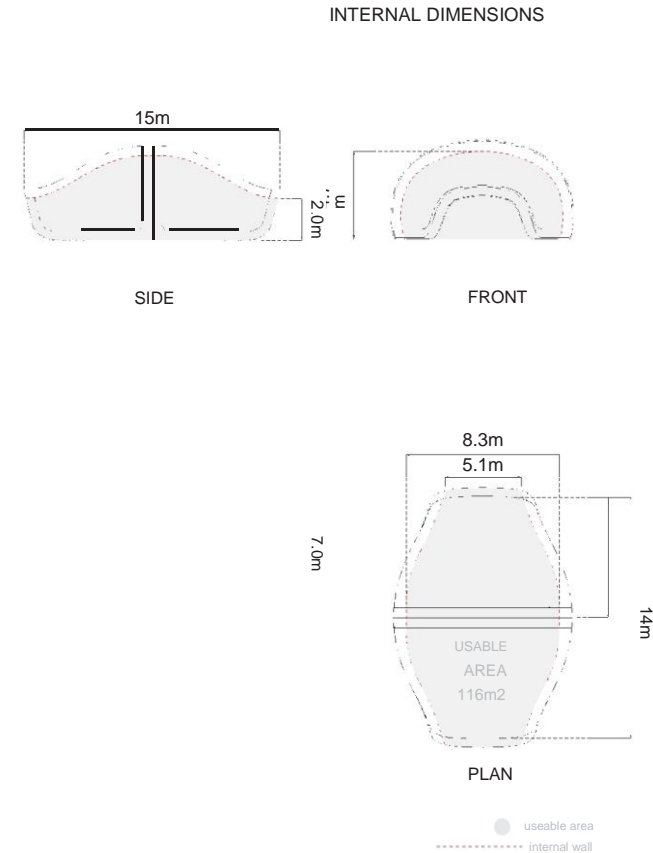

**Please note** > It is the responsibility of the client or site management to ensure that the power used for the running of the fans is secure and tested. Evolution Dome cannot be held responsible for any power failure under any circumstances.

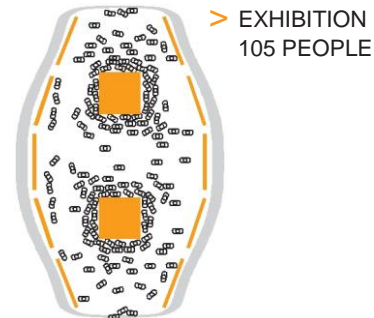
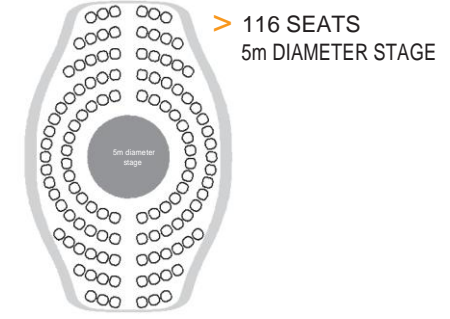
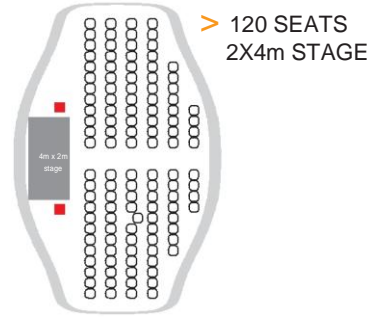
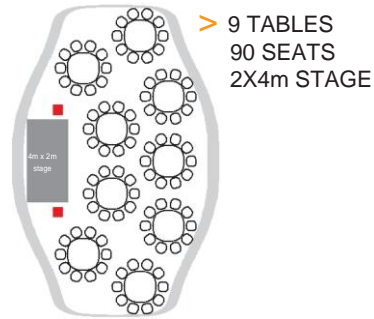
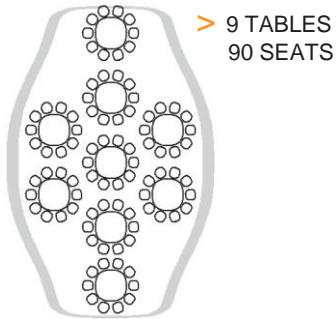

○ TABLE + 10 SEATS

● STAGE

■ SPEAKERS

■ EXHIBIT

○ PEOPLE (BASED ON 1 PERSON PER M SQ)

Due to the unique nature of the Evolution Dome Structures the interiors are used for a vast range of functions with varying layouts. The layouts within this document demonstrate how to best optimize the space for dining, conference, presentation, and exhibition layouts.

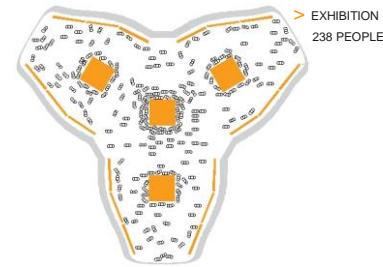
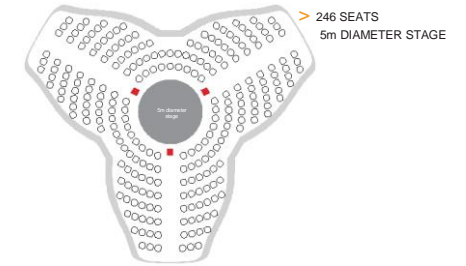
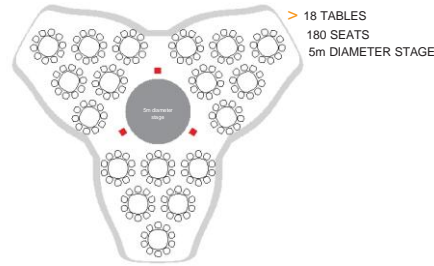
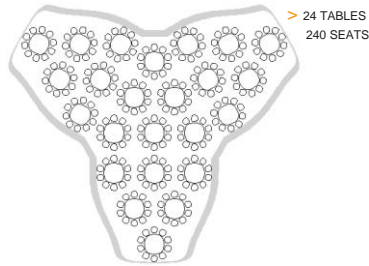

- TABLE + 10 SEATS
- STAGE
- SPEAKERS
- EXHIBIT
- PEOPLE (BASED ON 1 PERSON PER M SQ)

Due to the unique nature of the Evolution Dome Structures the interiors are used for a vast range of functions with varying layouts. The layouts within this document demonstrate how to best optimize the space for dining, conference, presentation, and exhibition layouts.

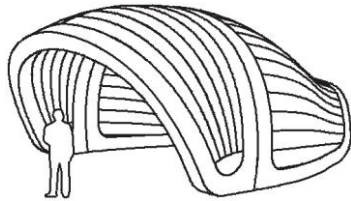

TURLE GT STAGE COVER  
TURTLE HALF + AWNING

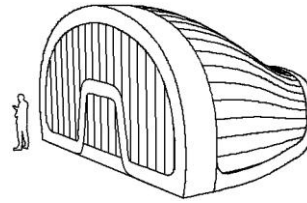

TURTLE HALF + END WALL

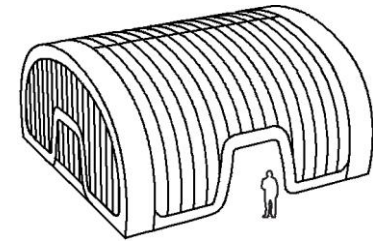

10m EXTENSION TUNNEL + 2 END WALLS

With the Turtle GT Systems, Inflate have created the most dynamic and diverse modular system that the events industry has ever seen. Whether it is a smaller open fronted space or an enormous closed space environment, the combinations offered by this innovative system are limitless!! Evolution Dome are confident that whatever your requirements, the Turtle GT System can provide the solution!

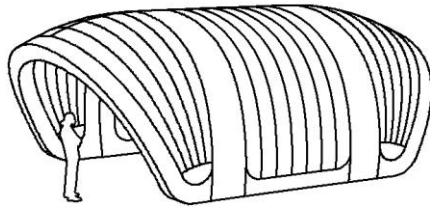

ARMADILLO+5  
5m EXTENSION TUNNEL + 2 AWNINGS

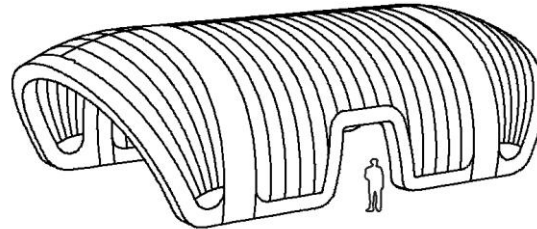

ARMADILLO+10  
10m EXTENSION TUNNEL + 2 AWNINGS

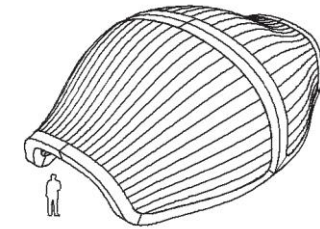

TURLE GT  
2 TURTLE HALVES

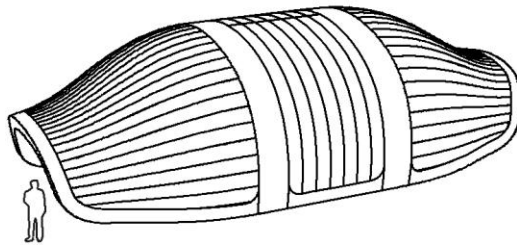

TURLE GT+5  
2 TURTLE HALVES + 5m EXTENSION TUNNEL

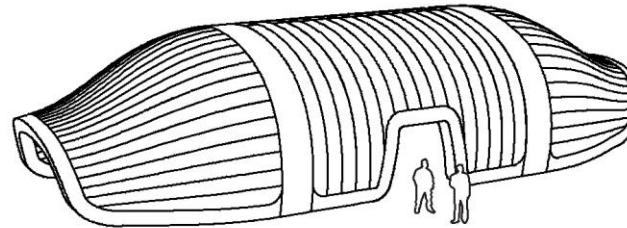

TURTLE GT+10  
2 TURTLE HALVES + 10m EXTENSION TUNNEL

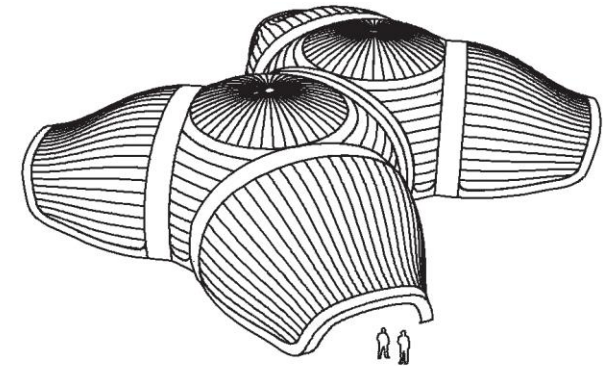

MEGA TURTLE GTS  
4 TURTLE HALVES + 2 HUBS

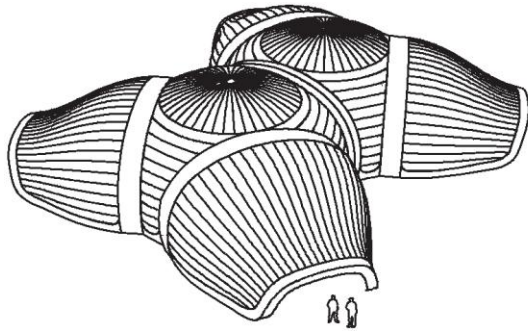

MEGA TURTLE GTS  
4 TURTLE HALVES + 2 HUBS

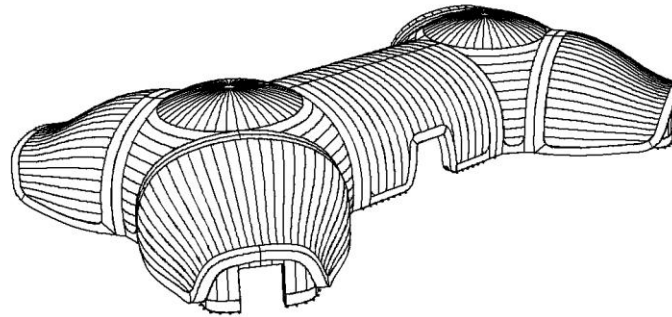

MEGA TURTLE GTS+10  
4 TURTLE HALVES + 2 HUBS + 10m EXTENSION TUNNEL

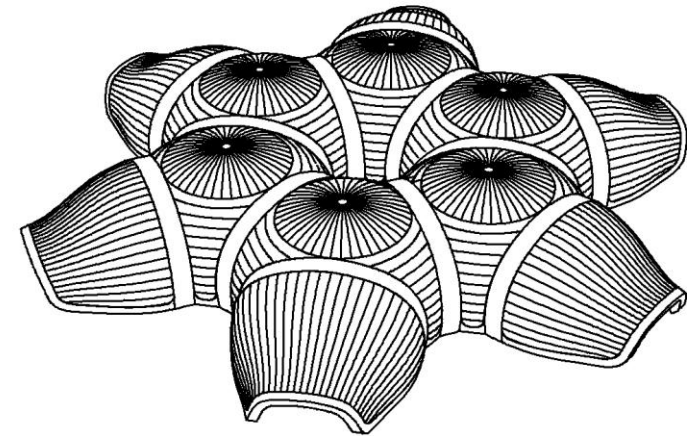

TURTLE GTS LOTUS-PLEX 6  
TURTLE HALVES + 6 HUBS

**Branding >**

Branding can be applied permanently to the structures as screen print or off set digital printing at the source of production. Temporary branding can be added as vinyl or Dacron adhesive panels to pre made structures.

Please note that not all artwork is possible to apply to the structures and samples of proposed artwork should be supplied as soon as possible for review by Evolution Dome for sizing and positioning requirements.

**Bespoke Colours >**

Bespoke colours of structures can be supplied, but this will increase the general lead-time by c.30 days. All the designs can be manufactured as black out structures with black or white interiors for enhanced laser and projection effects.

**Fabrics and Materials >**

All the structures are constructed from Rip Stop Nylon and Polyester Re enforced PVC. Other fabrics can be used in the production subject to the tests and costs.

All fabrics are tested for performance of flammability for textiles used in the construction of marquees and similar textiles structures to standards: BS 7837:1996 / BS 5438:1989 / Test Method B

**Lighting >**

Evolution Dome offers a range of LED and Florescent lighting to enhance the evening effect of the structures. Florescent Internal lighting provides lower wall ambient lighting effect. The LED lights can be used as colour changing spotlights or wall washers. The internal trussing systems can be used to mount lighting for specialist lighting effects. Evolution Dome will liaise with Lighting specialists to help tailor their buildings where possible to enhance this product offer.

**Wind Loading >**

We recommend that all of our structures can be used in wind loads of up to 30mph based on the standard ground fixing specified in this document.

The structures can and will stay stable in higher wind loads with extra ground fixings and can be further enhanced with internal trussing to achieve full building regulations for permanent installations.

The structures are either secured to the ground using internal ballast which fits inside the walls of the structures via a zip opening or by tying to ground anchors such as 'platypus' anchors or 'terra' bolts. All the structures have 50mm webbing tie loops at approx 450mm around the outer parameter of the structures. Each of these tie points are capable to hold 150kg load.

These structures have been designed for the demand of temporary events to offer efficient installation and de rig time. We recommend a 500kg ground anchor every 2m around the parameter of the structures. These are then connected via 5 ton webbing straps. Please refer to build manual. The higher the wind load the greater the deflection in the structures. This will be subject to the form and the direction the wind comes from. We recommend that any internal fit outs of the structures have no sharp objects closer than 1.5m to inner membrane at heights over 2m unless internal trussing is used.

As a company Evolution Dome cannot be responsible for weather conditions and the health and safety on site is always the responsibility of the projects site manager.

**Flooring >**

There is a range of flooring we can offer: Snap Lock flooring offers a good solution for quick installation of plastic flooring to cover grass. This will stop build up of mud and dirt. It will follow the contours of the grass and should not be expected to give a flat totally level floor. The tiles are 15mm thick. The floor can be further enhanced with carpet or other top finishes. 100mm wooden ply decking shaped to the profile of the structure offers the best opportunity for creating a solid level floor for the buildings. The flooring is leveled using packers up to 150mm. For any installation where the undulations are greater than this may require specific design solutions to achieve a level floor? The flooring is able to have solid wooden doors and other such features combined with it. This flooring can be covered with exhibition carpet / rubber flooring and have recessed lighting etc.

Aluminum adjustable staging is available in various square and rectangular sizes of 1220 by 1220mm / 1830 by 1220mm / 2440 by 1220mm. Please note the staging cannot be shaped to the profile of all the inflatable structures. The stage heights start at 800mm and the loading capacity varies from 350 – 750kg subject to the height and design.

**Weather Conditions >**

Evolution Dome has no control over the weather conditions during use and advise all events are monitored for extreme weather. All the structures are designed as airflow systems and this acts as an air repulsion to stop water from coming into the structure allowing it to run down the outside of the structure to the ground. As with all outdoor events this is 99% effective in most situations.

Whilst none of our structures have been engineered for specific snow loads, we have been able to maintain our structures in snow conditions by increasing the number of fans used, installing additional trussing support as well as maintaining a higher temperature internally within the structure. However, loads cannot be guaranteed and would need to be reviewed on an individual project, condition and location basis.

**Wind Loading >**

We recommend that all of our structures can be used in wind loads of up to 30mph based on the standard ground fixing specified in this document.

The structures can and will stay stable in higher wind loads with extra ground fixings and can be further enhanced with internal trussing to achieve full building regulations for permanent installations.

The structures are either secured to the ground using internal ballast which fits inside the walls of the structures via a zip opening or by tying to ground anchors such as 'platypus' anchors or 'terra' bolts. All the structures have 50mm webbing tie loops at approx 450mm around the outer parameter of the structures. Each of these tie points are capable to hold 150kg load.

These structures have been designed for the demand of temporary events to offer efficient installation and de rig time. We recommend a 500kg ground anchor every 2m around the parameter of the structures. These are then connected via 5 ton webbing straps. Please refer to build manual. The higher the wind load the greater the deflection in the structures. This will be subject to the form and the direction the wind comes from. We recommend that any internal fit outs of the structures have no sharp objects closer than 1.5m to inner membrane at heights over 2m unless internal trussing is used.

As a company Evolution Dome cannot be responsible for weather conditions and the health and safety on site is always the responsibility of the projects site manager.

**Trussing >**

All Evolution Dome structures are designed to free stand without internal trussing. The internal trussing we offer has been designed specifically for each of the structures as an architectural enhancement that can be used to enhance the interior with lighting / projectors / plasma screens acoustic speakers etc. The Trussing will further aid the wind performance of the buildings by reducing any deflection that could occur in high wind loads. Structural trussing for permanent installations is developed and produced upon site-specific requirement and request only.

**Connectability >**

All the Evolution Dome Turtle GT's have a standardized connection system for joining them together in any combination possible both enhancing the look and increasing the size options available. Please refer to Inflate for more details.

**Doors & Closures >**

Most of our structures come with lightweight zip in night sheets and inflatable zip in closures. The structures can also be fitted with painted wooden doors. These doors come as double or single openings subject to the design, and can have push bar fire latches. The doors are recommended for use with ply decking or aluminum adjustable decking, but can be used directly onto other surfaces subject to site conditions and client expectations. Airclad© doors are available for the higher specification architectural designed solutions.

**Noise Reduction >**

The outdoor structures use a range of 0.75 or 1.5hp fans. These run at 70 – 90db and for most outdoor events this sound will dissipate. However Evolution Dome has developed its own patent pending noise reduction system for the outdoor fans. This will reduce the noise to 50db at source and down to 40db at 15m. This is on par with standard ambient noise outside a city! The noise reduction units allow the structures to be used as intimate working spaces as well as big launch events and parties.

**Transportation >**

By nature of inflatable products they pack down to a fraction of their inflated size. Transportation can be as simple as putting an OIAB on the back of a scooter to fly across a city to make a presentation. The idea of the pop up presentation with Evolution Dome's inflatable products has so much more theatre than other flimsy alternatives.

The Luna matches this simplicity of portability and ease of erection. The larger the buildings become the bigger these packages are with small vans and trailers offering quick and simple transport solutions. Though the Trident (Evolution Dome's largest structure) weighs in around 1400kg it still packs into a case (2m x 1.7m x 1.4m) and can be transported on a trailer. As your event grows and the demands for flooring and other accessories become larger, the transportation can be simply extended to artic trucks.

**Evolution Dome Warranty >**

Evolution Dome offer a one year warranty which covers the quality of fabric, manufacture and suitability for use, in line with our Inflate Build & Care Manuals.

However, due to the nature of use and conditions in which some structures are erected, Evolution Dome reserve the right to inspect, decide and advise on a suitable course of action in conjunction with this warranty.

Any additional enhancers to the structure, such as lighting & flooring will obviously affect the 'Min Set Up Time' as shown above and should be taken into account for any event. All dimensions, weights and timings and general details in this document are subject to change, and Evolution Dome maintain the right to change these at any time it sees fit. For further information on this please contact us (contact details below).



Capricorn House  
Fen Road, Pidley  
Cambs, PE28 3DD

Tel: 07513 492992  
07970 901267

Email: [Ash@Evolutiondome.co.uk](mailto:Ash@Evolutiondome.co.uk)  
[Dan@Evolutiondome.co.uk](mailto:Dan@Evolutiondome.co.uk)

[www.Evolutiondome.co.uk](http://www.Evolutiondome.co.uk)